

DIRECT DRIVE 2-motor
FULL AUTOMATIC TURNTABLE

PL-530

OPERATING INSTRUCTIONS

KCT
KUT



Walnut grained vinyl cabinet

 PIONEER®

WARNING: TO PREVENT FIRE OR SHOCK HAZARD,
DO NOT EXPOSE THIS APPLIANCE TO RAIN OR
MOISTURE.

Thank you for purchasing the Pioneer Direct Drive Fully-Automatic Stereo Turntable. Please read this Instruction Manual carefully clear through to the end, so that you fully understand it before using your turntable.

CONTENTS

Features	2
Attaching the Cartridge	3
Assembly Procedure	4
Part Names	5
Adjusting the Tonearm	6
Dust Cover	7
Connection to Stereo Amplifier	7
Panel Facilities	8
Fine Adjustment of Speed	10
Installation	10
Playing Procedure	11
Turntable Care and Maintenance	13
Trouble? Check It Out	14
Specifications	15

FEATURES

High Torque DC Servo Motor Uses Hall Elements

The DC brushless Hall motor combines Hall elements with a high torque motor and a semi-conductor circuit. Hall elements, production-engineered by Pioneer, are used to switch the polarity in the motor. Since purely electronic commutation is used for switching the motor drive circuit, harmful noise is not generated, and smooth, even rotation can be obtained with high durability. By combining precision engineering with high fidelity circuit technology, excellent characteristics of 70 dB (DIN-B) or more S/N, and 0.03% (WRMS) wow and flutter have been achieved.

Two-Motor Fully Automatic Turntable Uses Precision Geared Motors

A specialized precision geared motor is used for the lead-in and return functions of the tonearm. Since the return function employs the velocity detector principle, stable operation is consistently maintained.

Newly Developed High-Sensitivity S-Shaped Tonearm

High sensitivity angular contact bearings are used for both vertical- and horizontal-axis movement of the tonearm, so that there is minimum play and friction. High sensitivity and durability are obtained.

Both an anti-skating mechanism and a lateral balance adjustment are built in, therefore, even when a low tracking force, high compliance cartridge is used, the unit turns in an excellent tracking performance. An independent tonearm lift device is incorporated in the fully-automatic mechanism, so the stylus can be raised easily even during playing without damage to the stylus or record.

Panel Layout Facilitates Easy Operation

This layout places the speed adjusters, function buttons, record size selector, and arm lift lever all at the front of the unit, concentrating controls for easy operation. A headshell stand is built-in for a spare cartridge. The dust cover uses free-stop fastener hinges.

Cabinet Designed for Sound Quality

The power source transformer and operating mechanisms are all mounted in the hard particle board cabinet, while the platter and tonearm are kept floating above the cabinet by the floating suspension, contributing to the improvement of the tone quality. External vibrations are doubly damped by the insulators to obtain a very high resistance against acoustic feedback ("howling").

ATTACHING THE CARTRIDGE

This turntable comes without cartridge, enabling the user to mount a cartridge of his choice. There are different kinds of cartridges available today, including moving magnet (MM), moving coil (MC) and induced magnet (IM) types. These types of cartridges can be used with the PL-530, but the cartridge selected should be between 4 and 14.5 grams in weight.

Since the tonearm of the PL-530 is a universal type, your optional cartridge with standard type headshell can be attached with no problem.

When the cartridge is to be used in the headshell supplied with this turntable, install the cartridge very carefully as follows:

1. Take out the headshell, cartridge mounting screws, nuts, washers, and overhang gauge from the accessory box (Refer to page 5).
2. Being careful not to confuse the polarities attach the lead wires to the cartridge. The polarities are as follows:
 - white : L (left channel signal)
 - blue : LG (left channel ground)
 - red : R (right channel signal)
 - green : RG (right channel ground)
3. Attach the cartridge lightly to the headshell, using the screws, nuts, washers, etc.
4. Adjust the overhang using the accessory overhang gauge. To do this, hold the headshell against the overhang gauge as shown in Fig. 2, aligning the indicator line on the overhang gauge with the stylus positioned, tighten it firmly in place with the mounting screws, being careful that it does not tilt to one side.

USE OF SUB WEIGHT

When a heavy cartridge (over 9.5 grams) is used, attach the accessory subweight to the rear end of the counterweight shaft (Fig. 3).

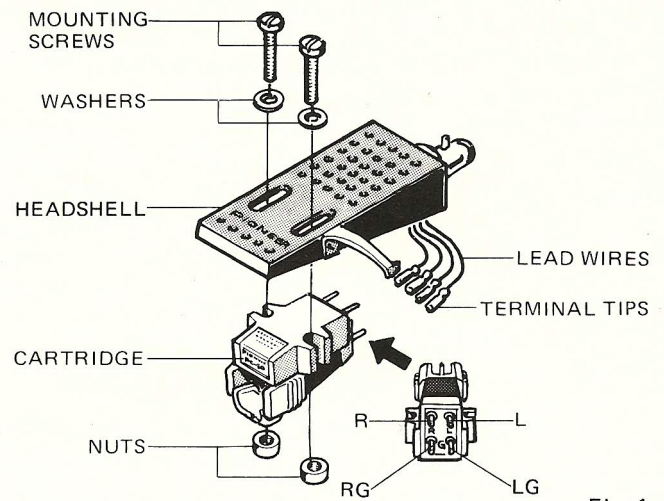

Fig. 1

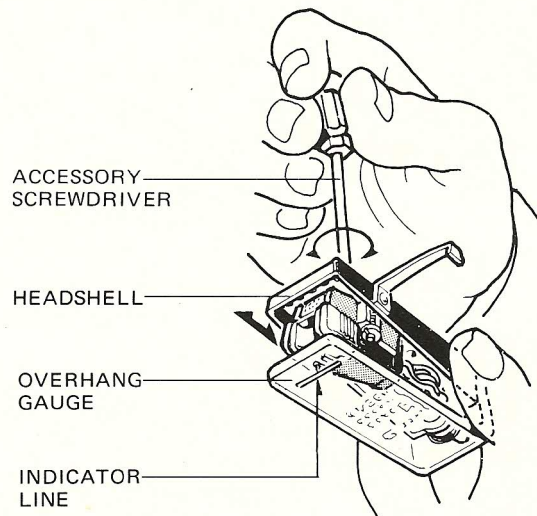

Fig. 2

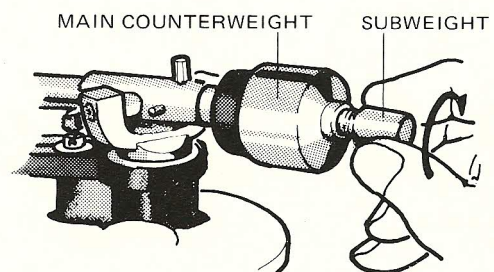

Fig. 3

ASSEMBLY PROCEDURE

1. REMOVAL OF TONEARM PACKING

To protect the tonearm during shipping, it is covered with protective packings. Tear off the tape and remove these packings, being careful not to apply excessive force to the tonearm (Fig. 4).

2. REMOVAL OF CLAMP SCREWS

During shipment, the subpanel is held against the cabinet by three clamp screws. Remove these screws with a Phillips screwdriver (Fig. 5). When these screws are removed, springs will cause the platter and tonearm to "float" above the cabinet.

3. ATTACHMENT OF PLATTER

Set the platter down over the center shaft. Since the platter is rather heavy, be careful not to apply excessive force to the center shaft. Next, lay the platter sheet and trim on the platter (Refer to next page).

4. ATTACHING HEADSHELL

Place the headshell on the end of the tonearm. Turn the locking collar to tighten it in place (Fig. 6).

5. ATTACHING LATERAL WEIGHT

Using the accessory screwdriver, attach the lateral weight to the lateral bar. Tighten the lateral weight to the lateral bar, 18–23mm from the tonearm (Fig. 7). Even when a new cartridge is mounted, it is not necessary to re-adjust the lateral weight.

6. ATTACHING THE MAIN COUNTERWEIGHT

Slide the main counterweight onto the counterweight shaft on the rear of the tonearm, and tighten it by turning it one or two turns in the direction of the arrow in Fig. 8.

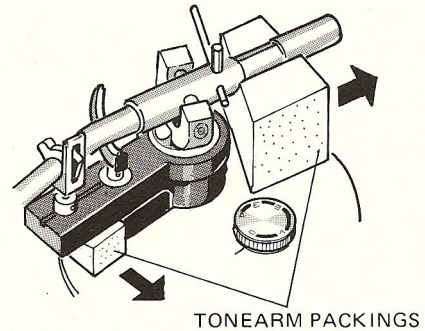

Fig. 4

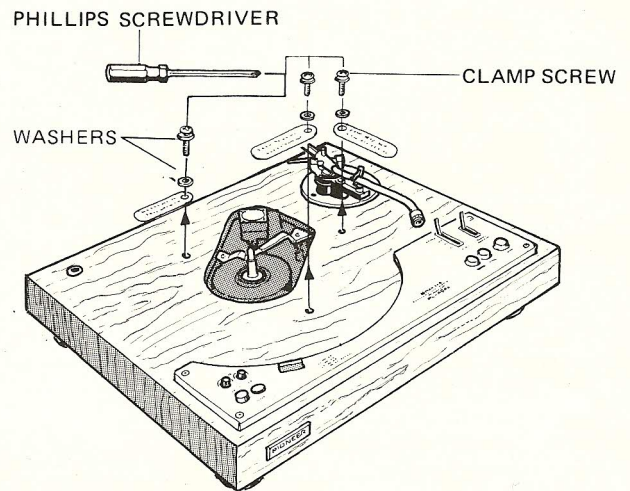

Fig. 5

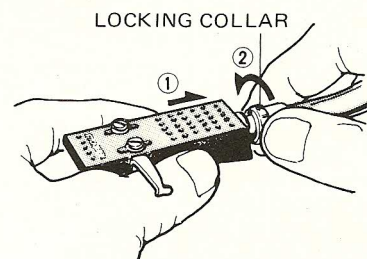

Fig. 6

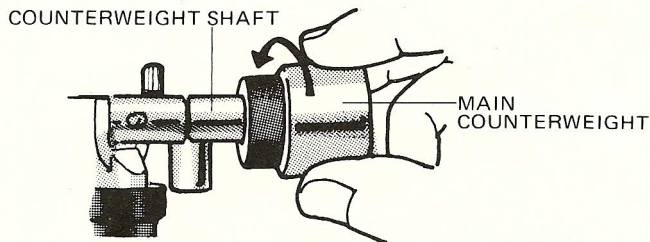

Fig. 8

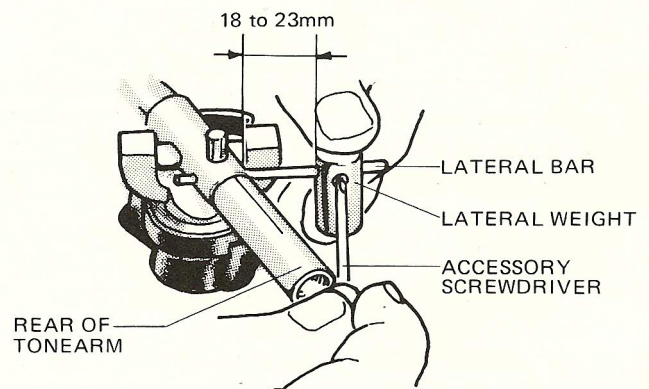
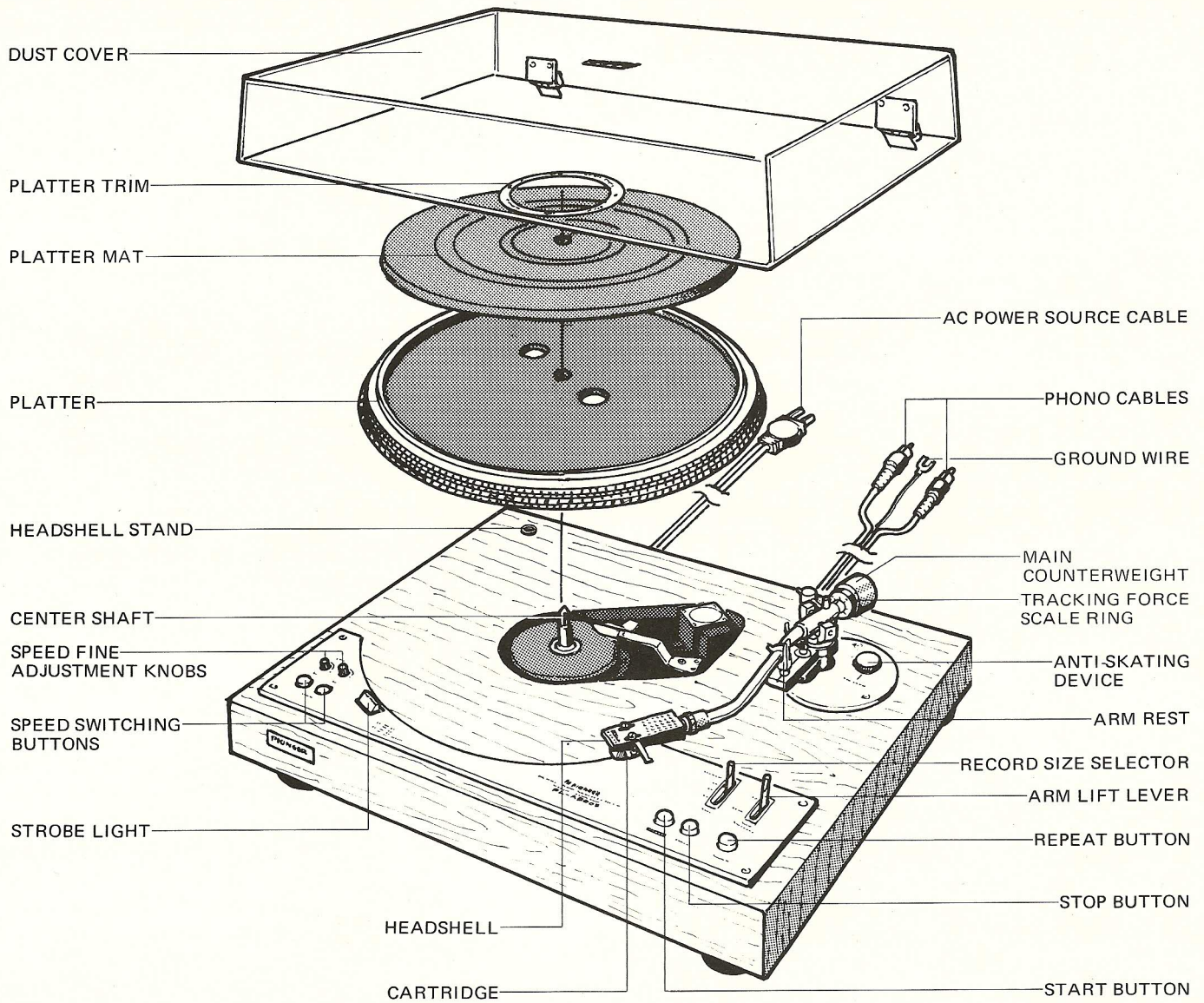

Fig. 7

PART NAMES



ACCESSORY NAMES

The following parts are included in the accessory box:

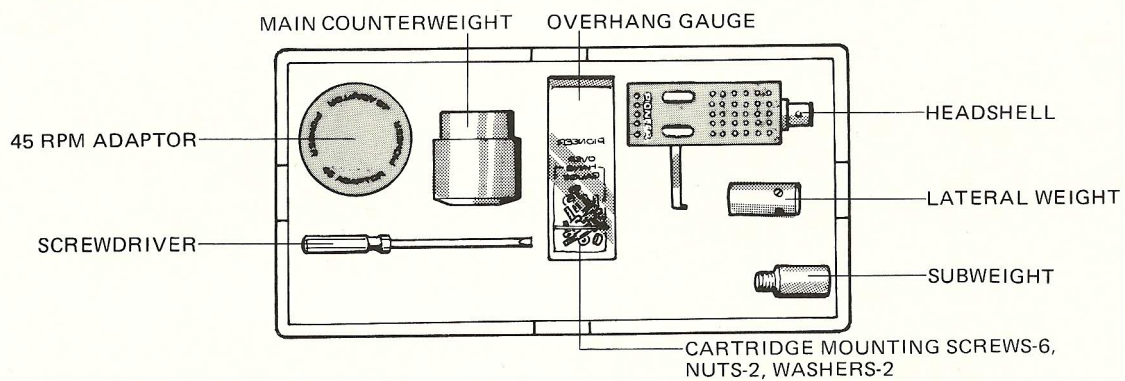

ADJUSTING THE TONEARM

DISENGAGING THE AUTO MECHANISM

Because this is a fully-automatic turntable, it is necessary to disengage the auto mechanism before adjusting the tonearm balance.

1. Plug the power source cable into an AC outlet.
2. Set the record size selector [SIZE] to MANUAL.
(Refer to page 9.)

3. Push the START button so the platter starts rotating.

4. Without pushing the STOP button (while the platter is still rotating), unplug the power source cable from the outlet.

This will disengage the auto-mechanism.

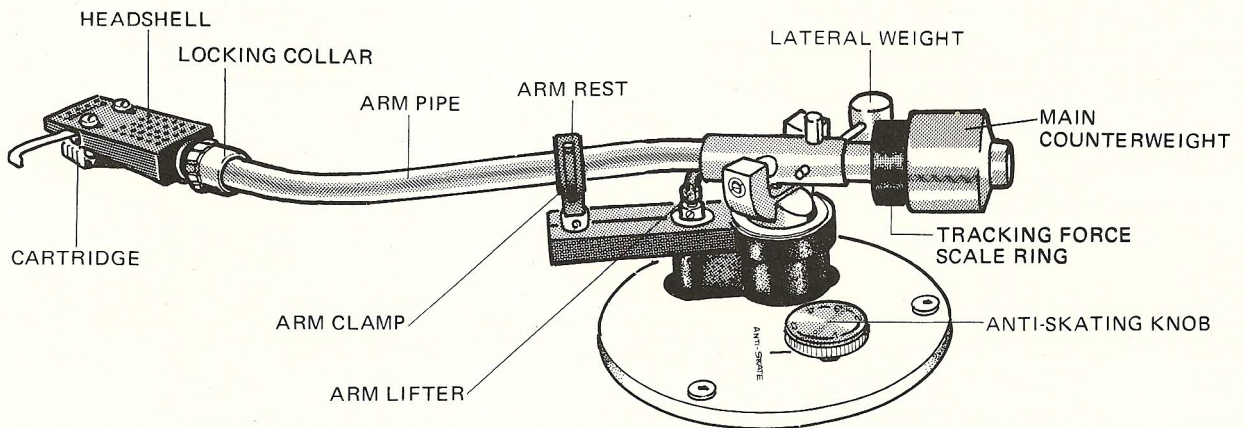

LEVEL BALANCE ADJUSTMENT

1. Set the anti-skating knob [ANTI-SKATE] to "0" (Fig. 10).
2. Remove the cartridge stylus cover.
3. Set the arm lift lever [ARM ELEVATION] to the DOWN position.
4. Release the arm clamp, and move the tonearm to the space between the arm rest and the platter, being very careful not to damage the stylus.
5. Turning the counterweight, adjust the tonearm balance, so that the tonearm is perfectly level, leaning neither towards the headshell end nor towards the counterweight end (Fig. 9-A). Figs. 9-B and C show the tonearm when it is not properly balanced.
6. Return the tonearm to the arm rest, fasten the arm clamp, and attach the stylus cover.
7. Plug the power source cable into an AC outlet. Since the platter will start rotating, push the STOP button until you hear the stop mechanism operate (about 1-2 seconds), and the platter will stop rotating.

Now the automatic mechanism is ready for operation.

8. Since the tracking force is zero when the tonearm is balanced level, turn just the tracking force scale ring in front of the counterweight, and set the "0" on the scale to the index line on the shaft (Fig. 10).

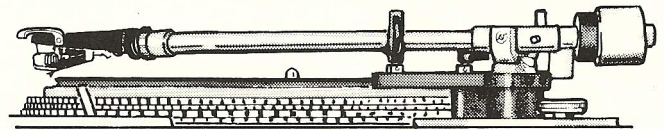

Fig. 9-A: Tonearm properly balanced

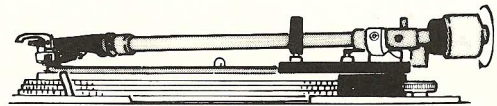

Fig. 9-B: Headshell end is too heavy. Turn the counterweight in the direction of the arrow.

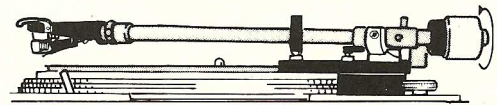

Fig. 9-C: Counterweight end is too heavy. Turn the counterweight in the direction of the arrow.

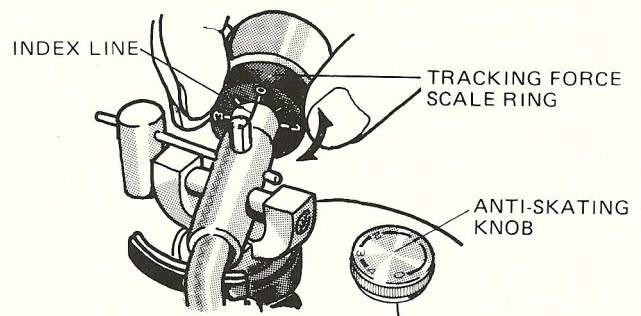

Fig. 10

ADJUSTING TRACKING FORCE

Turning the counterweight, set the correct tracking force opposite the index line on the counterweight shaft (Fig. 11). The tracking force scale ring has 0.5 gram steps, and one full turn of the counterweight will yield a tracking force of 4 gram.

ANTI-SKATING ADJUSTMENT

To Adjust the anti-skating mechanism, turn the ANTI-SKATE knob so that the number corresponding to the required tracking force is opposite the index line (Fig. 12).

The numbers on the anti-skating adjusting knob correspond to 1 gram of tracking force.

DUST COVER

Attach the dust cover by inserting the hinge knobs into the fittings on the rear panel of the cabinet. When attaching the dust cover, hold the lower part of the dust cover from behind the turntable as shown in Fig. 13, and it will slide smoothly into place. To remove the dust cover, first open it all the way, hold it firmly at the bottom as shown in the figure, and lift it straight up.

CONNECTION TO STEREO AMPLIFIER

The phono cables, ground wire, and power source cable are attached to the rear panel of the PL-530 turntable. The way in which the phono cables are connected to the amplifier will depend on the type of cartridge used.

- If the cartridge is a moving magnet (MM) or induced magnet (IM) type, the phono cables may be plugged directly into the PHONO MAG or PHONO terminals of the amplifier.
- If a low output moving coil (MC) cartridge is used, the phono cables are plugged into the PHONO MC terminals of the amplifier. If there are no MC input terminals on the amplifier, a special purpose transformer will have to be used.
- Other types of cartridge will require special connections and adaptors. The instructions given in the manual which is provided with the cartridge should be read with care to insure proper connection of the phono cables.

The phono cable with the white plug (marked L) is for the left channel, the one with the red (marked R) is for the right. The thin, black wire with the split lug connector on the end is the ground wire. This should be firmly attached to the ground connection (GND) on the amplifier. The final step before using turntable is to plug the power cord into an AC outlet.

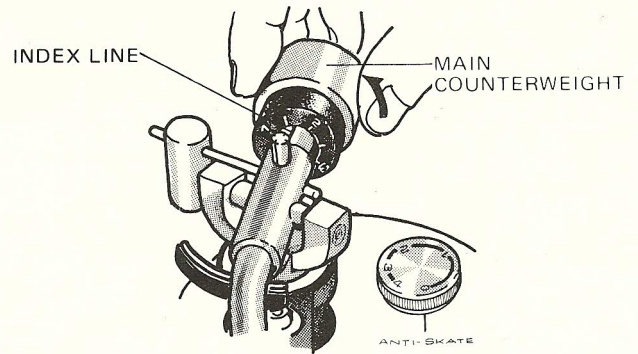

Fig. 11

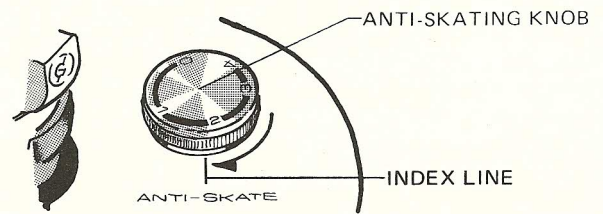

Fig. 12

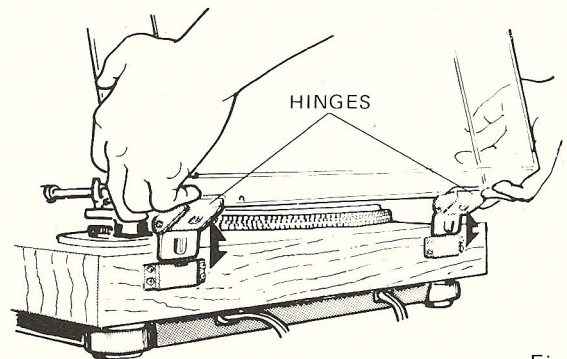

Fig. 13

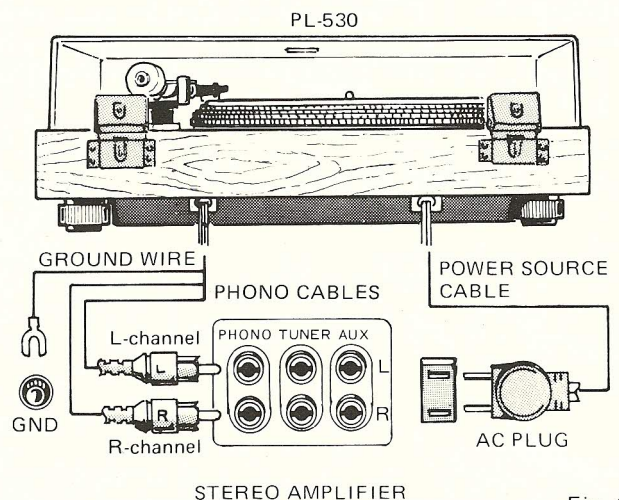

Fig. 14

PANEL FACILITIES

HEADSHELL STAND

Store your spare cartridge here. Insert cartridge, aligning cartridge guide pin with groove in the headshell stand. The 45 rpm adaptor can also be kept here.

NOTE:

Depending on how the headshell is inserted, it can contact the platter or dust cover. Be careful to insert it with the finger lift pointed inward.

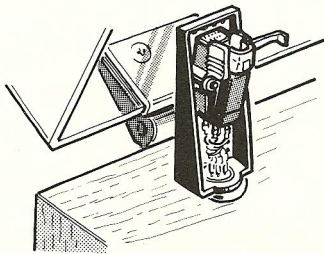

45 RPM ADAPTOR

Place over the center shaft when playing 45 rpm EP (large hole) records.



STROBE LIGHT

When the platter rotates, this lamp lights stroboscopically.

33-1/3 RPM SPEED FINE ADJUSTMENT KNOB

Perform fine adjustment of 33-1/3 rpm speed with this knob, while watching the strobe marks. When this knob is turned in the "+" direction, the speed increases; when turned in the "-" direction, the speed decreases. (Refer to instructions for FINE ADJUSTMENT OF SPEED on page 10.)

45 RPM SPEED FINE ADJUSTMENT KNOB

Perform fine adjustment of 45 rpm speed with this knob, while watching the strobe marks. When this knob is turned in the "+" direction, the speed increases; when turned in the "-" direction, the speed decreases. (Refer to instruction for FINE ADJUSTMENT OF SPEED on page 10.)

33-1/3 RPM BUTTON [33]

Push this button when playing a 33-1/3rpm record.

45 RPM BUTTON [45]

Push this button when playing a 45-rpm record.

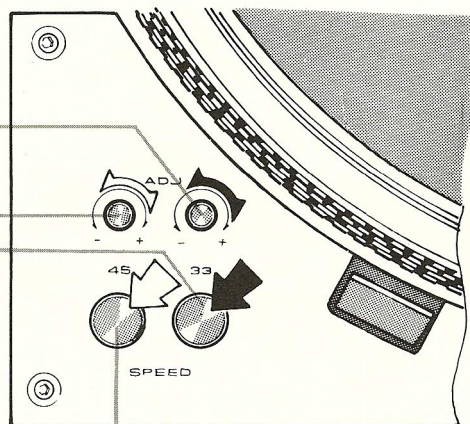

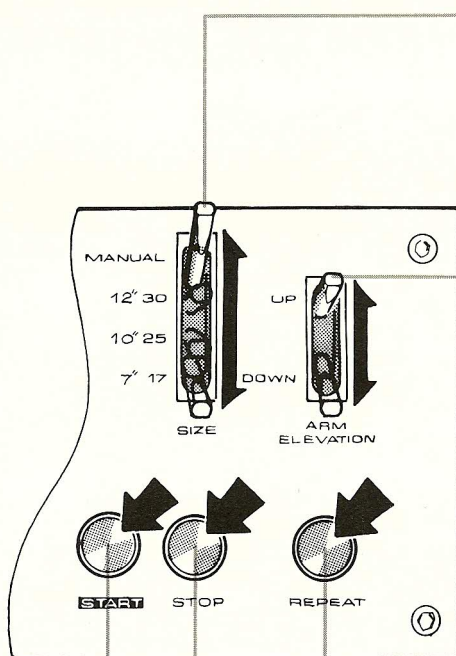

RECORD SIZE SELECTOR

Operating this lever enables the turntable to be switched from manual to automatic operation.

- MANUAL . . .** Set here to operate tonearm manually.
- 12" 30** Set here to play 30 cm LP records automatically.
- 10" 25** Set here to play 25 cm LP records automatically.
- 7" 17** Set here to play 17 cm records automatically.

NOTE:

For automatic playing, always switch the record size selector before pushing the START button. If the record size selector is switched while the tonearm is in motion, the stylus may not descend at the correct position or it may move to the new position while contacting the record surface causing record and stylus damage.

ARM LIFT LEVER

The tonearm is raised and lowered with this lever.

- UP** Moving the lever to this position raises the tonearm manually.
- DOWN** Moving the lever to this position lowers the tonearm manually. Leave the lever here for automatic operation.

FUNCTION SELECTOR BUTTONS

- REPEAT** Push this button to play the same record over and over. To release the repeat function, push the STOP button.
- STOP** When this button is pushed while a record is being played, the tonearm returns to the arm rest. Then the platter stops rotating and power source is shut off.
- START** When this button is pushed, the platter starts rotating. When the record size selector is set to an automatic position, the tonearm moves to the designated position and begins playing.

ARM REST

The arm rest supports the tonearm when it is not in use. When the turntable is not being used for a while, close the clamp around the tonearm as shown in the figure.

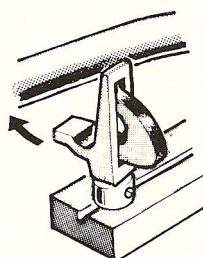

Open the clamp

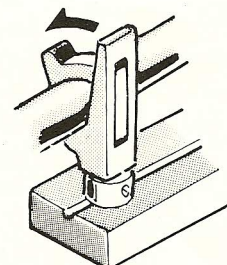

Close the clamp

FINE ADJUSTMENT OF SPEED

The platter rotation speed is adjusted according to the following procedure.

1. Set the record size selector to the MANUAL position.
2. Push the START button to start the platter rotation.
3. Push the 33-1/3rpm button, and watch the strobe marks.
4. When the strobe marks seem to flow to the right, the platter is rotating slower than the rated speed; turn the 33-1/3rpm speed fine adjustment knob in the clockwise (“+”) direction, until the strobe marks come to rest.

When the strobe marks seem to flow to the left, the platter is rotating faster than the rated speed; turn the 33-1/3rpm speed fine adjustment knob in the counter-clockwise (“-”) direction, until the strobe marks come to rest. (Refer to Fig. 15.)

5. Next, push the 45rpm button, and while watching the strobe marks, adjust the 45rpm speed fine adjustment knob in the same manner as for 33-1/3rpm, described above.

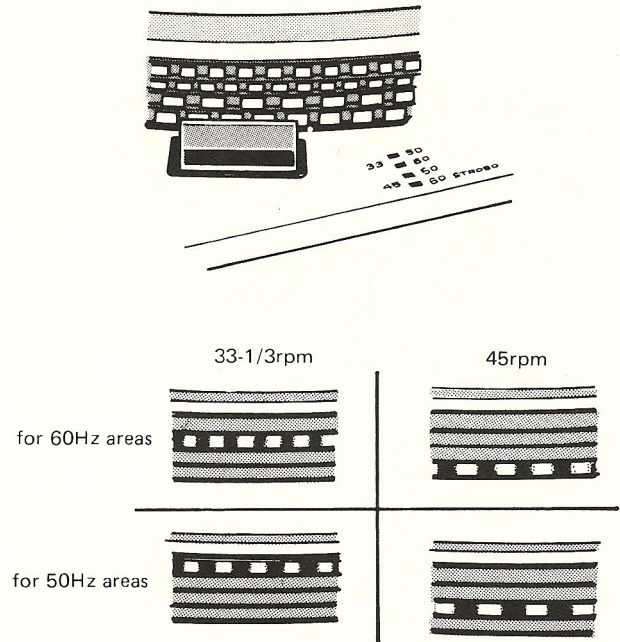

Fig. 15

INSTALLATION

When installing your PL-530, please avoid the following conditions:

Conditions to be Avoided	Possible Problems Caused
<ul style="list-style-type: none"> ● Place exposed to direct sunlight, high temperature or high humidity. ● Unstable surface ● Damp or dusty place ● Where there are heavy vibrations, such as on top of speakers. ● Adjacent to power transformer of amplifier. ● Place where alcohol, insecticides, or inflammable substances are frequently used. 	<ul style="list-style-type: none"> ● Can cause rust or interfere with insulation. ● Will interfere with normal operation of turntable (jumping of stylus). ● Can cause scratches or noise. ● Can cause howling. ● Can cause hum, noise. ● May cause corrosion of the front panel.

PLAYING PROCEDURE

The numbers shown in the illustrations indicate playing procedure.

AUTOMATIC MODE

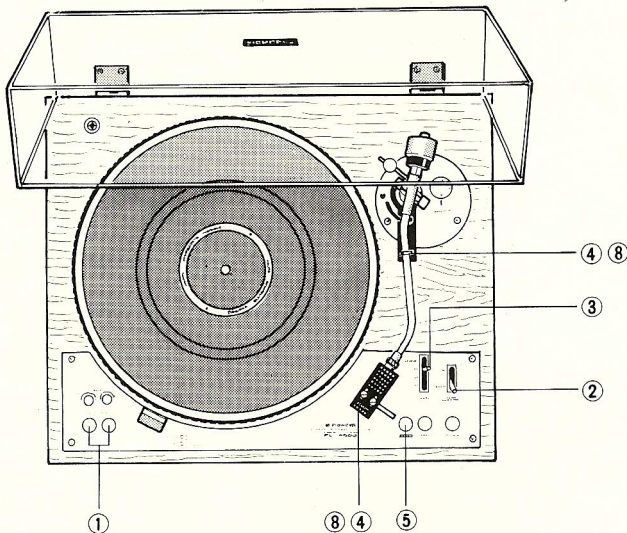

Procedure

1. Place the record on the platter, and push the appropriate speed button.
2. Make sure that the arm lift lever is in the DOWN position.
3. Set the record size selector [SIZE] to either 30, 25, or 17, according to the size of the record.
4. Remove the stylus cover, and release the tonearm clamp.
5. Gently push the START button (until you hear the start mechanism operate). The strobe light will come on, and the platter will begin rotating. Then the tonearm will slowly move over the lead-in grooves and the stylus will descend to start playing.
6. Set the tone and volume controls of the stereo amplifier to the desired levels, and enjoy the recording.
7. At the end of the record, the auto-return mechanism will operate, and the tonearm will return to the arm rest. At the same time, the power source will be shut off, and the platter will stop rotating.
8. Fasten the tonearm clamp, and attach the stylus cover to protect the stylus.

MANUAL MODE

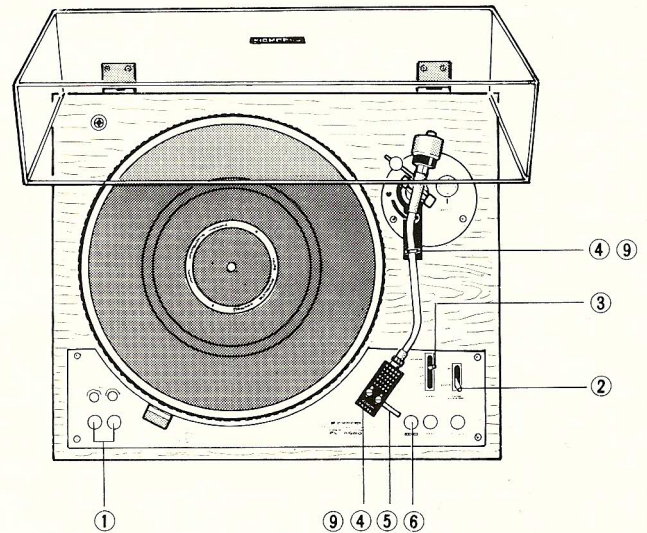

Procedure

1. Place the record on the platter, and push the appropriate speed button.
 2. Make sure that the arm lift lever is in the DOWN position.
- NOTE:*
However, that the tonearm stays in raised position although the arm lift lever is DOWN.
3. Set the record size selector to the MANUAL position.
 4. Remove the stylus cover, and release the tonearm clamp.
 5. Gently move the tonearm over the desired position on the record.
 6. Gently push the START button (until you hear the start mechanism operate). The strobe light will come on and the platter will begin turning. The stylus will slowly descend to the record surface and begin playing.
 7. Set the tone and volume knobs of the stereo amplifier to the desired levels.
 8. At the end of the record, the auto-return mechanism will operate, and the tone arm will return to the arm rest. At the same time, the power source will be shut off, and the platter will stop rotating.
 9. Fasten the tone arm clamp, and attach the stylus cover to protect the stylus.

When the strobe marks seem to flow to the right or left, adjust the speed by turning the speed fine adjustment of Speed on page 10.

REPEAT MODE

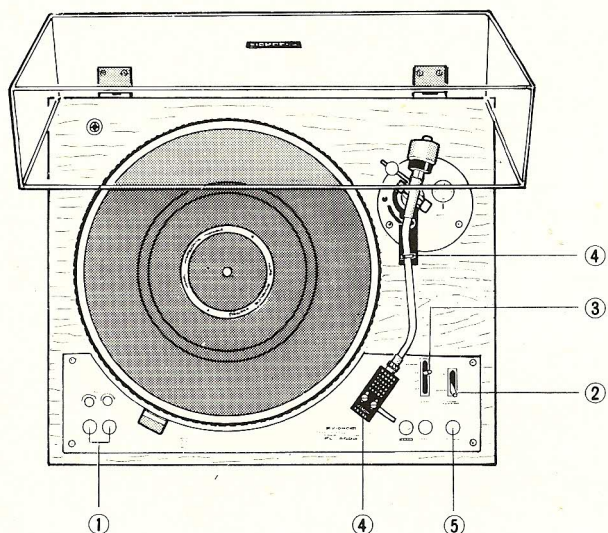

Procedure

1. Place the record on the platter, and push the appropriate speed button.
2. Make sure that the arm lift lever is in the DOWN position.
3. Set the record size selector [SIZE] to either 30, 25, or 17, according to the size of the record.
4. Remove the stylus cover, and release the tonearm clamp.
5. Push the REPEAT button. The strobe light will come on, and the platter will begin rotating. Then the tonearm will slowly move over the lead-in grooves, and the stylus will descend to start playing.
6. Set the tone and volume knobs of the stereo amplifier to the desired levels, and enjoy the recording.
7. At the end of the record, the auto-return mechanism will operate, and the tonearm will return to the arm rest. Then, the tonearm will again move over the record, and the record will be played again. To stop the repeat playing, push the STOP button.

TO STOP THE RECORD WHILE PLAYING

Push the STOP Button

The tonearm will rise from the record and return to the arm rest. At the same time, the turntable power source will be shut off and the platter will stop rotating.

NOTE:

During manual mode, the tonearm can be raised by moving the arm lift lever to the UP position, and returned manually to the arm rest, but the platter will not stop rotating. To stop the platter rotating, push the STOP button.

TO TEMPORARILY INTERRUPT PLAYING

Move the Arm Lift Lever to the UP Position

Since the arm lift mechanism is independent of the auto-mechanism, the tonearm can be raised and lowered in either the automatic or manual mode. This feature is very convenient for listening to just one band from an LP, for example.

CAUTIONS

- Make a point of always cleaning the stylus with a soft brush each time before and after use, and cleaning records with a good-quality cleaner.
- When changing headshells, always fasten the tonearm to the arm rest with the tonearm clamp, to help avoid applying excessive force to the tonearm.
- Be careful not to bump against the turntable while it is in use, as this can result in damage to the stylus or the record.
- Do not force the tonearm closer than 40mm to the center shaft. This can damage the internal mechanism and make fully automatic operation impossible.
- Only place one record at a time on the platter. When two or more records are stacked on the platter, the stylus will not contact the record groove perpendicularly, and normal playing will not be possible.
- Do not disconnect the AC cord while the stylus is on a record, as this may result in damage to the stylus or the record.
Also, when the AC cord is plugged into an outlet on the amplifier, plug it into one that is unswitched.

TURNTABLE CARE AND MAINTENANCE

ADJUSTMENT OF AUTOMATIC DESCENT POSITION

The location at which the stylus descends on the record surface in the automatic mode is set at the factory, and should not require readjustment. However, if for any reason the stylus descends in the wrong location, adjust the tonearm as follows:

- 1 Place a 30cm LP record on the platter.
2. Set the record size selector to 30, and push the START button. This is to confirm how far off the mark the descent position is. Be careful not to allow the stylus to be damaged.
3. When the direction and extent of the deviation are understood, turn the starting position adjusting screw with the accessory screwdriver, adjusting it as follows:
 - When the stylus descends inside of the lead in grooves (too far from the center), turn the adjusting screw clockwise;
 - When the stylus descends inside of the lead in track (too close to the center), turn the adjusting screw counter-clockwise.
 Each half turn of the adjusting screw moves the starting point about 6mm.

NOTE:

When adjusting the automatic descent position, be careful not to damage the stylus or record.

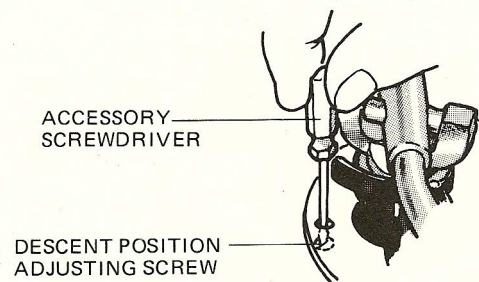

Fig. 16

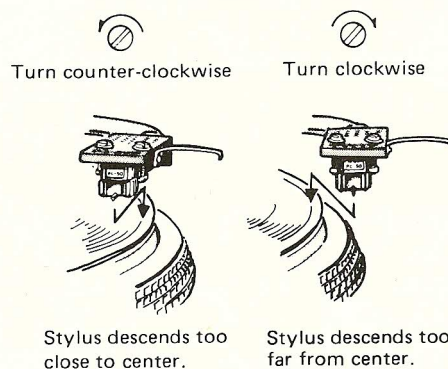

Fig. 17

NEVER OBSTRUCT PLATTER ROTATION BY HAND

While the platter is rotating, do not restrain it with your hands, etc., as this can cause breakdowns.

CORRECT MOTOR OPERATION REQUIRES PLATTER INSTALLATION

If the motor is run with the platter removed, the motor will not operate normally, and may seem to have broken down, but if the platter is installed, it will rotate properly.

ABOUT THE CABINET

When the cabinet or dust cover becomes dusty or dirty, wipe them clean with a polishing cloth or other dry, soft cloth. The surface can be eroded by furniture wax, benzine, insecticides, or other inflammable materials.

LUBRICATION

Since the PL-530 uses oil-less bearings, no lubrication is required.

A Word About Howling or Acoustic Feedback

“Howling” is a phenomenon which occurs when vibrations from a speaker are transmitted by the air or the floor to the turntable and cartridge, so that the entire room seems to resonate. If this occurs, either move the turntable to some place not affected by the vibrations, or mount it on a stand that effectively absorbs these vibrations.

TROUBLE? CHECK IT OUT

Sometimes an operational fault can be mistaken for an equipment malfunction. Before bringing your turntable in for service, check the points described below. Then, if the problem has not been resolved, contact your nearest Pioneer dealer.

- Platter does not rotate ————— Power source is unplugged. → Plug firmly into AC outlet.
[If the cord is plugged into a switched AC outlet on your stereo amplifier, turn the power switch of the amplifier on.]
- No sound is produced ————— Phono cable is unplugged or improperly connected. → Connect phono plugs firmly to the correct input terminals. [Refer to page 7.]
 - Headshell is not properly attached. → Firmly tighten locking collar.
 - Cartridge lead wires are loose. → Insert pins firmly. [Refer to page 3.]
[Make sure amplifier is being properly operated: the function switch is set to PHONO, the tape monitor switch is on, and the volume is sufficient.]
- Musical tempo is off ————— Record speed is not set properly. → Push the correct rpm button (33 or 45).
 - Rotation speed is not properly adjusted. → Watching the strobe marks, adjust the rotation speed with the speed adjustment knobs. [Refer to page 10.]
- Strobe mark movement cannot be stopped ————— The correct speed adjusting knob is not being turned. → Adjust the correct speed adjusting knob [Refer to page 8 and 10.]
- Excessive noise is produced ————— Ground wire is disconnected. → Connect it properly. [Refer to page 7.]
 - Record surface is dusty or dirty. → Clean with good quality cleaner.
 - Dust has collected on stylus. → Clean stylus.
 - Tracking force is too low. → Adjust to the proper tracking force. [Refer to page 7.]
 - The clamp screws have not been removed. → Remove them. [Refer to page 4.]
[When noise is produced even when the stylus is not in a record groove, the turntable is being affected by the amplifier or some other electrical equipment. Reconsider the location of the turntable and other components.]
- Sound is distorted ————— Stylus is worn. → Replace with new stylus.
 - Dust has collected on stylus. → Clean stylus.
 - Tracking force is too low. Adjust to the proper tracking force. [Refer to page 7.]
- Tonearm does not descend in automatic mode ————— Arm lift lever is set to UP. → Set to DOWN.
- Tonearm does not move when START button is pushed in automatic mode ————— Arm clamp is still fastened. → Unfasten.
 - Record size selector is set to MANUAL. → Set to proper position for size of record to be played.
- Stylus does not descend to correct position in automatic mode ————— Adjust automatic descent position as described on page 13.

SPECIFICATIONS

Motor and Turntable

Motor	Brushless DC servo Hall motor
Turntable Platter	330mm diam. aluminum alloy die-cast
Moment of Inertia	260kg·cm ² (including platter mat)
Speeds	33-1/3 and 45rpm
Speed Control Range	±2% (individual control for 33-1/3 and 45rpm)
Wow and Flutter	Less than 0.03% (WRMS)
Signal-to-Noise Ratio	More than 70dB (DIN-B)

Tonearm

Type	Static-balance type, S-shaped pipe arm
Effective Arm Length	221mm
Overhang	15.5mm
Usable Cartridge Weight	4g (min.) to 14.5g (max.)
	(For cartridge weighs over 9.5g, attach the sub weight)

Subfunctions

Anti-skating force control
Lateral balancer
Stylus pressure direct-readout counter weight
Cueing device
Headshell stand
Strobe light
Free stop hinges

Accessories

45 rpm Adaptor	1
Overhang gauge	1
Screwdriver	1
Sub weight	1
Cartridge mounting screws	6
Cartridge mounting nuts	2
Cartridge mounting washers	2
Operating instructions	1

Miscellaneous

Power Requirements	AC 120V, 60Hz
Power Consumption	7W
Dimensions	480(W) x 170(H) x 390(D)mm 18-29/32(W) x 6-11/16(H) x 15-11/32(D)in.
Weight	10kg/22lb

NOTE:

Specifications and design subject to possible modification without notice, due to improvements.

